



# MAESTRO 3.0 BLUE MULTIMEDIA PLAYER

rev. 1.14



<b>WARRANTY</b>
THIS PRODUCT IS COVERED BY TWO-YEAR GUARANTEE FOR ANY MANUFACTURING TROUBLES. THE WARRANTY IS VALID IF ACCOMPANIED BY THE INVOICE OF PURCHASE

<p>Manufactured and distributed by:  <b>PASER s.r.l.</b> Strada Per Poirino 29 Villanova d'Asti (AT), 14019 Italy          Tel. 0039 (0)141 947694 Fax. 0039 (0)141 946000          Tech service 0039 (0)141 947676          Office hours (8.30-12.30 14.30-18.30) <a href="http://www.paser.it">www.paser.it</a>; <a href="mailto:paser@paser.it">paser@paser.it</a></p>
---

The information in this guide are purely for information purposes, therefore, are subject to change without notice. At the time of publication the information is correct and reliable. However Paser can not be held responsible for any consequences resulting from errors or omissions in this manual. Paser reserves the right to improve / change the product or manual without obligation to notify users.

universal battery recharge	<b>A2DP</b>	<b>AVRCP</b>	<b>HANDSFREE KIT</b>	<b>FULL DIGITAL AUDIO</b>
<b>STEERING WHEEL COMMANDS</b>	<b>CANBUS steering wheel connection</b>	<b>RESISTIVE steering wheel connection</b>	<b>GMLAN steering wheel connection</b>	<b>Plug &amp; Play harness ready</b>
<b>ID3 TAG visualization</b>	<b>Mp3 MPEG Layer 3</b>	<b>AUX-IN input</b>	Plays Windows Media™	<b>iPod Battery Recharge</b>
<b>R-D-S RADIO DATA SYSTEM</b>	<b>CERTIFIED USB</b>	<b>FIRMWARE upgradeable</b>	<b>SPEECH SYNTHESIS</b>	<b>WIRELESS remote control ready</b>

All registered trademarks belong to the legitimate owners.



**INTRODUCTION**

MAESTRO 3.0 BLUE is a multimedia player compatible with all USB pens and iPod/iPhone. Text information like Track Title, are shown in the radio display. The module is connected in series to the radio antenna and thanks to the FM RDS technology it can manage an high quality sound and also transmit all the information to the radio display.

The device is equipped with a speech synthesis system, this feature provides an high quality level of safety because all the operations made by the interface are indicated to the customer. MAESTRO 3.0 is upgradeable via USB. Device functions are totally manageable from your car steering wheel commands or by a wireless remote (optional).

**MORE THAN A RECEIVER**

MAESTRO 3.0 BLUE has a Bluetooth Hands Free built in that allows to manage Phone calls and music with A2DP protocol.

**CHARACTERISTICS**

- Bluetooth Hands Free
- A2DP Bluetooth Receiver
- Supported files format: MP3/AAC/WMA/M4A.
- Jack 3,5mm Aux-In Input
- User Menu displayed in the radio display through RDS.
- Menu Labels Speech Synthesis
- Compatible with additional wireless remote
- Steering Wheel Commands management
- FM modulator with 8 different selectable frequencies

**PACKAGE**

- 1 user manual
- 1 unit
- 1 free wires harness
- 1 USB extender
- 1 microphone

**General Information**

Size	87x133x35 mm
Weight	< 190 gr (without cables )

**Technical Information**

Power Input	12 Volt
Max Power Input	16 Volt
Min Power Input	8 Volt
Power Consumption	190 mA
Standby Power Consumption	<7 mA
Working Temperature Range	-20 +70 C

## TROUBLESHOOTING

**The radio band frequency is disturbed.**

Select a different radio frequency as described in the MENU SET UP in sub menu FREQUENCY at page 16.

**The audio is distorted and it is too low.**

Verify that the antennas plugs are correctly connected.

If the problem is with your USB, carry out a scanning of your MP3 files using MP3GAIN in order to normalize the volume. If the problem is with the AUX IN input, adjust the volume directly on the source.

**After the connection of the module the steering wheel commands don't manage any functions.**

Verify the correct connection of MAESTRO 3.0 Blue to the power cables of the vehicle.

Make a RESET of MAESTRO 3.0 Blue as described at page 6 of this manual.

Verify that the CANBUS, GMLAN or Resistive connections were done correctly.

Verify that the vehicle is in the compatibility list.

Verify that in case of resistive vehicle protocol, the self learning procedure was done correctly.

**It's not possible to carry out the self learning procedure for the resistive steering wheel commands.**

Make the self learning procedure of the steering wheel commands being sure to keep pressed each buttons for minimum 2 seconds.

Verify the vehicle compatibility consulting the connections attachment.

**When the car is off, MAESTRO 3.0 Blue doesn't switch off.**

Verify the ignition connections, if the vehicle is CANBUS the connection of the ignition wire is not required, if the vehicle is Resistive verify that the ignition wire is correctly connected .

**MAESTRO 3.0 Blue doesn't play the files stored in the USB pen.**

Be sure that the files stored are in MP3, AAC, WMA or M4A format and that the USB pen is working.

It is suggested to format the USB pen in FAT 32 mode with 512bytes sectors.

Remove files from the USB pen, format it and reload all files in the USB pen.

**MAESTRO 3.0 Blue is correctly working but it is not possible to enter the menu with the steering wheel commands.**

Verify the available configuration as described at pages 11, 12, 13 e 14. Attention some models of swc don't have the long pressure condition.

**MAESTRO 3.0 Blue doesn't play automatically the music from the USB pen during the start up.**

Some USB pens don't allow to start the reproduction during the switch on, if it happens please remove and insert again the USB pen.

**MAESTRO 3.0 Blue doesn't continue from last track point listened before switch it off.**

This feature is possible only when the track listened is in MP3 format.

**MAESTRO 3.0 Blue not found during a Bluetooth scan**

Check if the key is turned on

Disable and enable again Bluetooth from the device and execute another scan

**Track title is not shown in the display during Audio Bluetooth streaming**

Verify that the device supports Bluetooth AVRCP protocol

**Car Phone button doesn't allow to reply to a phone call received through MAESTRO 3.0 Bluetooth**

In some cars Phone buttons are dedicated to OEM Bluetooth systems and for this reason can't be used to manage MAESTRO 3.0 Blue.

## INSTALLATION

MAESTRO 3.0 BLUE is easy to install but we suggest to require the support of a qualified technician.

**Please turn off the key before starting to install the module.**

1. First of all you need to remove the OEM radio.

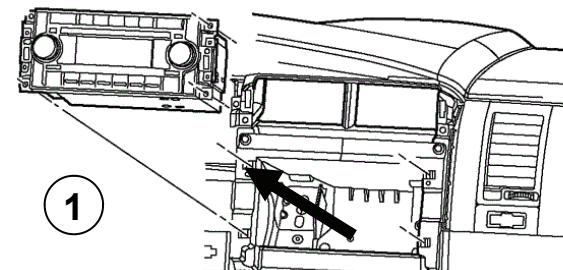

2. Disconnect the radio connector.

**ATTENTION! IF THE RADIO HAS A SECURITY CODE PROTECTION PLEASE BE SURE THAT IS AVAILABLE BEFORE DISCONNECT THE RADIO CONNECTOR.**

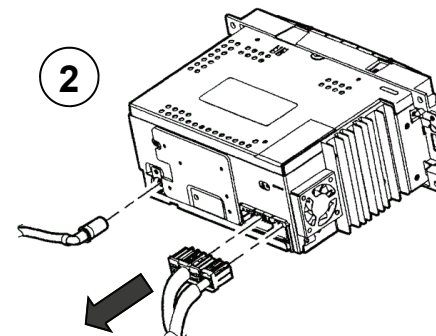

3. Please verify the steering wheel commands protocol in order to understand which kind of connection is to be made.

MAESTRO 3.0 BLUE can manage CANBUS, GMLAN and R-Ladder steering wheel commands protocols.

Steering wheel connection are explained in the attached document, in order to understand the logic please see the diagram at page 4.

If the vehicle is not equipped with steering wheel commands the interface management could be done with a wireless remote (optional) as explained at page 10.

**POWER AND STEERING WHEEL COMMANDS CONNECTIONS**

Power and steering wheel connections are located in the 22 poles connector as indicated.

Connect RED cable to the car radio 12VDC positive.

Connect BLACK cable to the ground.

Connect MAESTRO 2.0 BLUE-YELLOW cable to a positive ignition output.

**The BLUE-YELLOW wire must not be connected if the vehicle uses CANBUS or GMLAN protocol.**

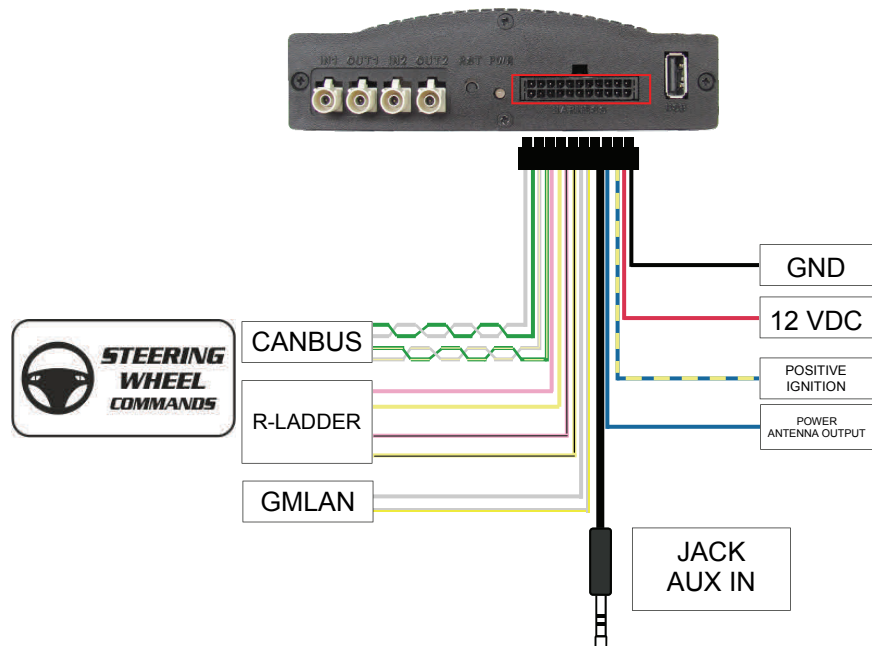

**Connect steering wheel interface wires in series to the OEM wires, for example in a car that uses CANBUS protocol is necessary to cut the CAN H wire and connect GREEN wire to the car side and GREEN/YELLOW to the radio side, the same must be done with CAN L and WHITE and WHITE/YELLOW wires.**

	WIRE COLOUR	FUNCTION
CANBUS WIRES	GREEN	CAN H INPUT
	WHITE	CAN L INPUT
	GREEN / YELLOW	CAN H OUTPUT
	WHITE / YELLOW	CAN L OUTPUT
R-LADDER WIRES	PINK	V1 INPUT
	YELLOW	V2 INPUT
	PINK / BLACK	V1 OUTPUT
	YELLOW / BLACK	V2 OUTPUT
GMLAN WIRES	GREY	GMLAN INPUT
	GREY / YELLOW	GMLAN OUTPUT

MAIN MENU	SUB-MENU 1	SUB-MENU 2	SUB-MENU 3
SETUP	SYSTEM	VERSION	BACK EXIT
		UPGRADE SYSTEM	INSERT KEY BACK EXIT
		AUTO PWR (ON/OFF) RDS TEXT (ON/OFF) BACK EXIT	
	BACK EXIT		
EXIT			

**MEANINGS**

**AUTO PWR** switches on automatically the interface when a new source is connected.

**RDS MODE** changes the RDS version used: normal (8 characters) and estende (64 characters)

MAIN MENU	SUB-MENU 1	SUB-MENU 2	SUB-MENU 3	
(OFF)				
(MUSIC)	(USB)	FIRST ROOT FOLDER BACK EXIT	FOLDERS LIST	
(SOURCE)	(IPOD) (USB) (A2DP) (AUXIN) BACK EXIT			
SETUP	(USB)	RANDOM (ON/OFF) REPEAT (ON/OFF) BACK EXIT		
	(AUX)	NAVI (ON/OFF) DETECT (ON/OFF) BACK EXIT		
	(A2DP)	AUTOCONN. (ON/OFF) AUTOPLAY (ON/OFF) BACK EXIT		
	BT	A2DP (ON/OFF) HFK (ON/OFF) BACK EXIT		
	FREQUENCY	87.70MHz 87.90MHz 88.10MHz 88.30MHz 88.50MHz 88.70MHz 88.90MHz 89.10MHz BACK EXIT		
	VOICE	LANGUAGE		ITALIAN ENGLISH LANG3 LANG4 BACK EXIT
		WELCOME MSG (ON/OFF) MENU MSG (ON/OFF) EVENTS MSG (ON/OFF) BEEPS (ON/OFF) BACK EXIT		
			VERSION	BACK EXIT
			UPGRADE VOICE	INSERT KEY BACK EXIT
			BACK EXIT	

Now connect the harness to the MAESTRO 3.0 Blue and the OEM connector back to the radio.

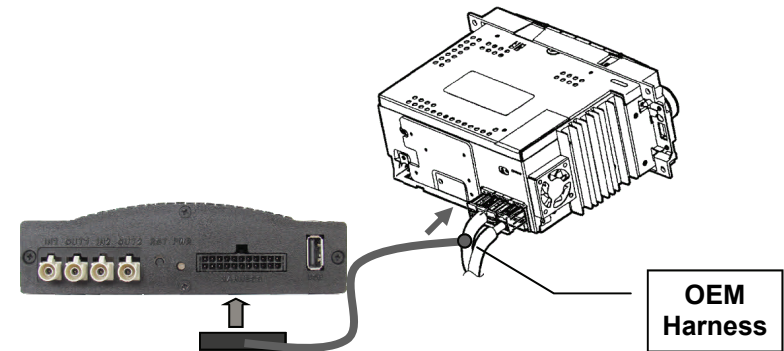

Connect the antenna adapter in series to the car antenna. Below is described a FAKRA antenna connection.

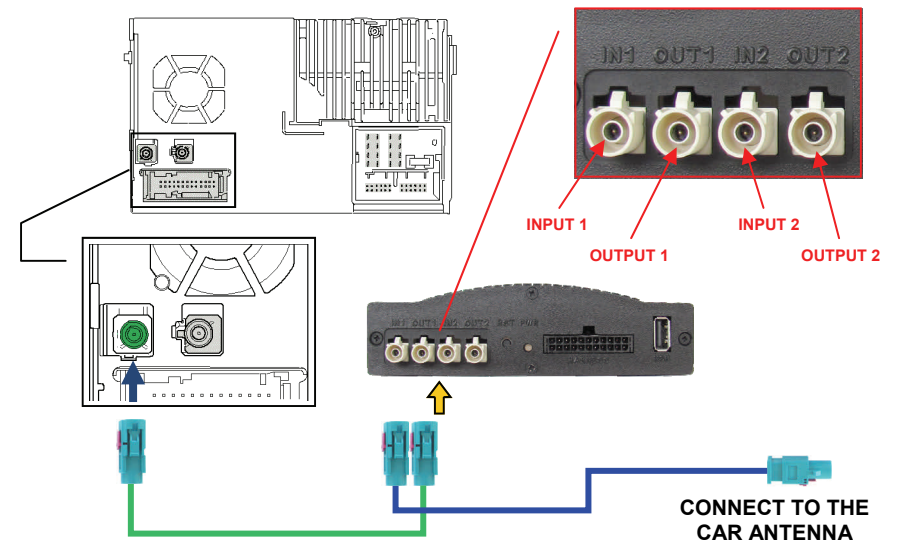

Different antenna adapters are available such as ISO, DIN, GT5.

**ATTENTION! RESPECT ALWAYS ANTENNA INPUT/OUTPUT CONFIGURATION**

**MICROPHONE CONNECTION**

Place the microphone in order to keep it pointed to the car driver and connect it to the module by the Jack input.

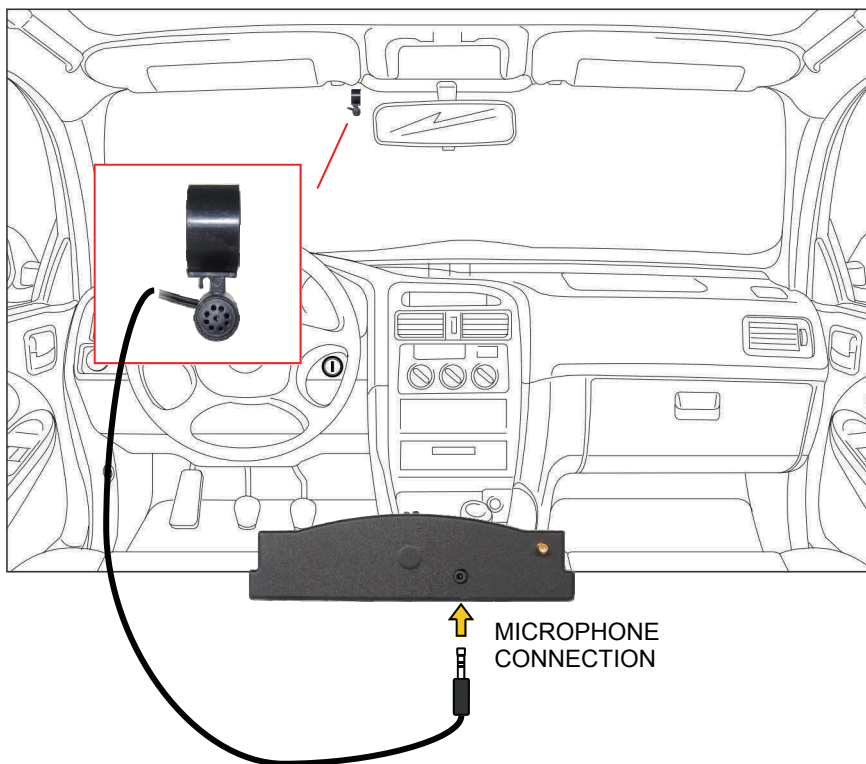

**MENU**

**MAESTRO 3.0 Blue** has a user-menu that is displayed on the radio display through the RDS; the same menu is pronounced by the vocal synthesis.

The menu can be run down by a remote control (optional) or by the steering wheel commands (for the compatible versions).

To enter the menu with the remote control, **please check the function at page 13**. With the steering wheel commands, the user can enter the menu by pressing for a long the SRC button or, if this button it is not available, by doing the sequence SEEK - / SEEK + / SEEK - / SEEK +.

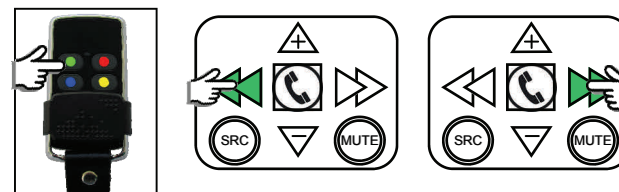

To scroll down the menu headings, the user can use the remote control indicators buttons or the steering wheel commands, by pressing the seek buttons.

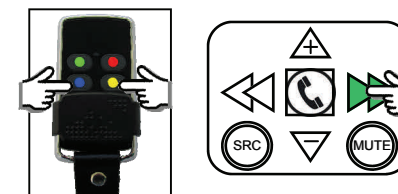

To entry into the sub-menus or to confirm a choice, please do a short pressure on the remote control on button A or, through the steering wheel commands, please do a short pressure on the SRC button. If this button is not available, please do the sequence SEEK - / SEEK +.

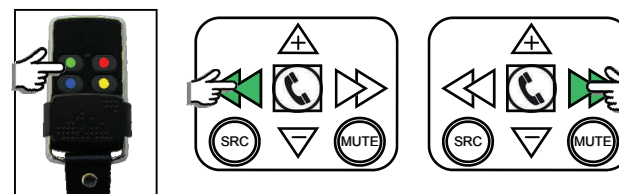

The menu managing allows to do all desired settings.

All possible handlings are displayed on the radio display and pronounced by the vocal synthesis too.

The menu includes various sub-menus.

Menu organization is tree-shaped and it's handled as described in the following table.

*Remote control can be optional or included . It depends on the item code required*

**Configuration 4:** **Short Pressure**  
**Long Pressure**

FUNCTION	CARS WITHOUT LONG PRESSURE BUTTON INFORMATION	CARS WITH LONG PRESSURE BUTTON INFORMATION
ON/OFF	- + - +	- + - +
Volume +	+	+
Volume -	-	-
Next Track	▶	▶
Previous Track	◀	◀
Next Playlist/Folder	◀ ▶	▶
Previous Playlist/Folder	▶ ◀	◀
Play/Pausa	SRC	SRC
Source	SRC SRC	SRC SRC
<b>MENU FUNCTIONS</b>		
Menu	SRC SRC SRC SRC	SRC
Next Menu	▶	▶
Previous Menu	◀	◀
Select	SRC	SRC
<b>PHONE FUNCTIONS</b>		
Phone Close	☎	☎
Phone Answer	☎	☎
Volume -	◀	◀
Volume +	▶	▶

In some cars Phone buttons are dedicated to OEM Bluetooth systems and for this reason can't be used to manage MAESTRO 3.0 Blue.

**ACTIVATION AND TUNING**

Once that all connections are done turn on the key:  
The LED will switch on fixed GREEN.



By default the system will transmit on the frequency 87.7 Mhz, then set this frequency as favorite

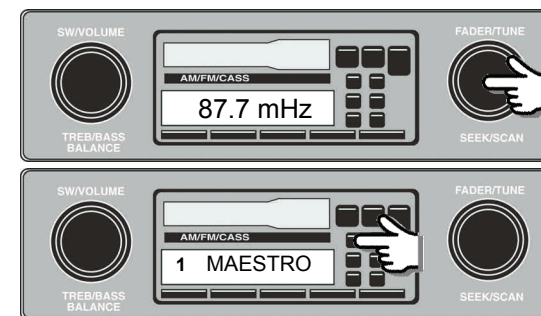

Each time that the key will turned on the system will switch on automatically and the speech synthesis system will pronounce the welcome message: "MAESTRO WISH YOU GOOD LISTENING".  
Reproduction will start immediately and RDS text will be shown on the radio and car display.

To switch off the module press in sequence from the steering wheel VOL+ VOL- VOL+ VOL - :

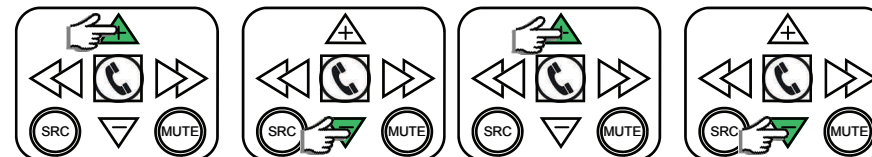

The same sequence could be use to switch on again the interface.

In case of an incorrect working of the steering wheel commands functions, please make a RESET of MAESTRO 3.0 Blue, as described below, by pressing the button of the unit till the LED of the module switch OFF.

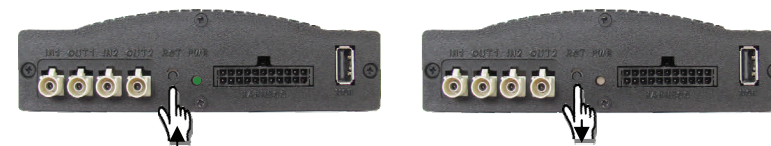

Menu headings and files titles contained into the audio sources are displayed thanks to MAESTRO 3.0 Blue RDS handling function. So, with the RDS function activated, all operations are also visualized on the radio display and, in case of OEM radio, they are visualized also on the vehicle display (if the OEM radio can write also on this one).

The displayed menu headings are the same for all the languages and they are set by default in English. Instead, for what concerning files titles, MAESTRO 3.0 Blue controls the information deriving from the mp3 TAG: if the TAG is present the unit displays up to a maximum of 64 characters; if it is not available, MAESTRO 3.0 Blue will display the file name but up to a maximum of 64 characters!

Folders names are displayed on the display too; also in this case, MAESTRO 3.0 Blue displays only the first 64 characters, so it's advisable to name the folders with maximum of 64 characters.

**USB / IPOD**

MAESTRO 3.0 BLUE can manage USB pens and iPod / iPhone / iPad devices. The module is equipped with an USB where is possible to connect compatible devices.

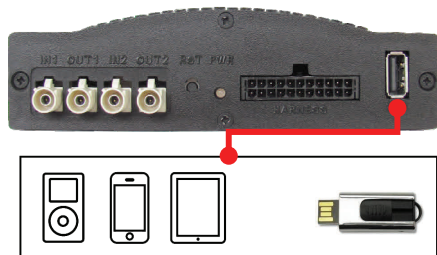

Reproduction will start automatically after the device connection, anyway it will be always possible to change the active source by the interface menu.

**Warning:** Paser can't guarantee that all available USB pens will be compatible. In the case that the module cannot recognize a USB pen, please format it in FAT32 and try again.

**AUXILIARY AUDIO INPUT**

MAESTRO 3.0 BLUE provides also an auxiliary audio input that allows you to connect any kind of device with a Jack 3,5 audio output. Audio will be recognized automatically and the interface will change source.

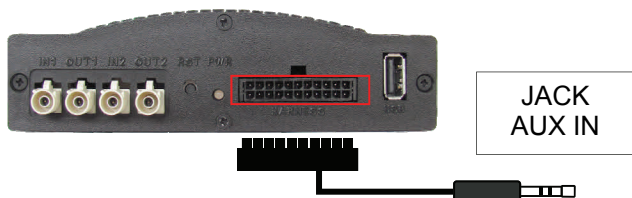

**Warning:** If the audio signal supplied to the interface has a too high volume it is possible that the interface could transmit a cropped signal, anyway if the audio signal has a too low volume it could not be automatically recognized.











































**Configuration 3:** **Short Pressure**  
**Long Pressure**

FUNCTION	CARS WITHOUT LONG PRESSURE BUTTON INFORMATION	CARS WITH LONG PRESSURE BUTTON INFORMATION
ON/OFF	- + - +	- + - +
Volume +	+	+
Volume -	-	-
Next Track	▶	▶
Previous Track	◀	◀
Next Playlist/Folder	◀ ▶	▶
Previous Playlist/Folder	▶ ◀	◀
Play/Pausa	SRC	SRC
Source	SRC SRC	SRC SRC
<b>MENU FUNCTIONS</b>		
Menu	SRC SRC SRC SRC	SRC
Next Menu	▶	▶
Previous Menu	◀	◀
Select	SRC	SRC
<b>PHONE FUNCTIONS</b>		
Phone Close	NOT AVAILABLE	📞
Phone Answer	📞	📞
Volume -	◀	◀
Volume +	▶	▶

**Warning:** In some cars Phone buttons are dedicated to OEM Bluetooth systems and for this reason can't be used to manage MAESTRO 3.0 Blue.



**Configuration 2:**  **Short Pressure**  
 **Long Pressure**

FUNCTION	CARS WITHOUT LONG PRESSURE BUTTON INFORMATION	CARS WITH LONG PRESSURE BUTTON INFORMATION
ON/OFF	   	   
Volume +		
Volume -		
Next Track		
Previous Track		
Next Playlist/Folder	 	
Previous Playlist/Folder	 	
Play/Pausa		
Source	 	 
<b>MENU FUNCTIONS</b>		
Menu	   	
Next Menu		
Previous Menu		
Select		
<b>PHONE FUNCTIONS</b>		
Phone Close		
Phone Answer		
Volume -	NOT AVAILABLE	NOT AVAILABLE
Volume +	NOT AVAILABLE	NOT AVAILABLE

**BLUETOOTH FUNCTIONS**

MAESTRO 3.0 Blue has built in an hands free and a Bluetooth audio receiver that allows to listen to the music directly from your device without wires. Phone calls and music reproduction are manageable by steering wheel commands or from wireless remote.

**BLUETOOTH PAIRING**

Bluetooth Pairing on MAESTRO 3.0 doesn't require PIN, you need just to scan available devices from your phone and connect it to the device "Maestro Blue" found. MAESTRO 3.0 Blue will connect automatically, on start up, to the last device connected..



**BLUETOOTH AUDIO**

Built in the interface is available a Bluetooth audio receiver that supports A2DP and AVRCP technology, it allows to stream music from a smartphone directly to the interface, visualizing track title on the radio display and managing the reproduction by steering wheel commands or by wireless remote.



**If the audio signal supplied to the interface has a too high volume it is possible that the interface could transmit a cropped signal.**



**REMOTE FUNCTIONS**

Remote control allows us to manage all the functions available with the steering wheel commands. Below please find the functions manageable.



ON	SHORT PRESS OF BUTTON D
OFF	SELECT OFF FUNCTION FROM THE MENU or LONG PRESS OF BUTTON D
Next Track / Channel	SHORT PRESS OF BUTTON C
Previous Track / Channel	SHORT PRESS OF BUTTON B
Next Playlist/Folder/Favourite	LONG PRESS OF BUTTON C
Previous Playlist/Folder/Favourite	LONG PRESS OF BUTTON B
Enter Menu	LONG PRESS OF BUTTON A
Menu scroll ahead	SHORT PRESS OF BUTTON C
Menu scroll back	SHORT PRESS OF BUTTON B
Menu confirmation	SHORT PRESS OF BUTTON A
Play/Pause	SHORT PRESS OF BUTTON A
Phone Answer	SHORT PRESS OF BUTTON A
Phone Close	SHORT PRESS OF BUTTON D

**CONTROL OF THE FUNCTION BY STEERING WHEEL COMMANDS**

MAESTRO 3.0 Blue can be controlled by the supplied remote control but also by the steering wheel commands (according to compatibilities).

Obviously, according to the different buttons available on the steering wheel the user can control MAESTRO 3.0 Blue

Not all CANBUS cars have long pressure button information and for this reason, where possible, some sequencies are used in order to execute additional functions.

Configuration 1: Short Pressure  
 Long Pressure

FUNCTION	CARS WITHOUT LONG PRESSURE BUTTON INFORMATION	CARS WITH LONG PRESSURE BUTTON INFORMATION
ON/OFF		
Volume +		
Volume -		
Next Track		
Previous Track		
Next Playlist/Folder		
Previous Playlist/Folder		
Play/Pausa	NOT AVAILABLE	NOT AVAILABLE
Source	NOT AVAILABLE	NOT AVAILABLE
<b>MENU FUNCTIONS</b>		
Menu		
Next Menu		
Previous Menu		
Select		
<b>PHONE FUNCTIONS</b>		
Phone Close		
Phone Answer		
Volume -	NOT AVAILABLE	NOT AVAILABLE
Volume +	NOT AVAILABLE	NOT AVAILABLE